

# ES38-18DK



KONGSBERG



## COMPACT DEPTH-RATED TRANSDUCER

### ES38-18DK

#### KEY FEATURES

- Wide-band split-beam transducer for fishery and fishery research applications
- Nominal frequency is 38 kHz
- Frequency range: 35 to 45 kHz
- Depth rate is 1500 m
- Beamwidth is 18°
- Max. transmit power is 450 W
- Physical dimensions:  
Diameter: 190 mm  
Height: 131 mm

The Simrad ES38-18DK is a compact transducer with a large bandwidth designed for fishery and research applications. The transducer is available in two different versions, a single-beam and a split-beam. The beamwidth is 18° at a nominal operating frequency of 38 kHz. The transducer is designed having three separate sectors.

The compact size and light weight of the transducer allows it to be mounted on a large variety of subsea platforms. The transducer is provided with two meters cable, and the cable is terminated with an 8- or 4-pin male connector that fits directly into our range of subsea transceivers.

The transducer is especially well suited for use with autonomous and subsea products such as the wideband autonomous transceiver (WBAT), wideband transceiver (WBT) mini and WBT tube.

#### Order information

To order the ES38-18DK transducer contact your local dealer or use our website.

<https://kongsberg.com/es38-18dk>

#### Transducer

- Order number:  
425594 Split-beam transducer  
428885 Single-beam transducer

Included in all deliveries:

- Transducer with 2 m cable using a 4- or 8-pin male SubConn® connector
- Test Report

## Technical specifications

The technical specifications and requirements provided are those valid when operating at the nominal frequency with all sectors excited simultaneously.

Kongsberg Maritime are continuously working to improve the quality and performance of our products. The technical specifications may be changed without prior notice and the specifications refers to typical figures for the product.

## Performance specifications

- Nominal frequency: 38 kHz
- Frequency range: 35 to 45 kHz
- Beamwidth: 18°
- Depth rating: 1500 m
- Figure of merit: -10 dB
- Max. source level: 212 dB re  $\mu\text{Pa}$  per V @ 1 m
- Transmit sensitivity ( $S_u$ ): 174 dB re  $\mu\text{Pa}$  per V @ 1 m
- Receive sensitivity ( $M_t$ ): -184 dB re 1 V per  $\mu\text{Pa}$  @ 1 m
- Sidelobe level: -17 dB
- Back radiation level: -20 dB
- Impedance (each sector): 75  $\Omega$

## Power specifications

- Max. transmit power: 450 W
- Max. pulse length: 8 ms
- Max. duty cycle: 2 %

## Weight and outline dimensions

- Physical dimensions:
  - Diameter: 190 mm
  - Height: 131 mm (body)
  - Total height: 212 mm
- Weight
  - In air: 9.2 kg (incl. cable)
  - In water: 5.5 kg (incl. cable)
- Cable length and termination: 2 m with 8-pin male SubConn® connector (MCIL8M)
- Cable diameter: 10.4±0.5 mm
- Bending radius:
  - Static: 100 mm (theoretical)
  - Dynamic: 150 mm (theoretical)

## Environment requirements

- Storage temperature:
  - Max.: +60°C
  - Min.: -20°C
- Operating temperature:
  - Max.: +40°C
  - Min.: -5°C

## ES38-18DK Single-beam transducer, typical figures

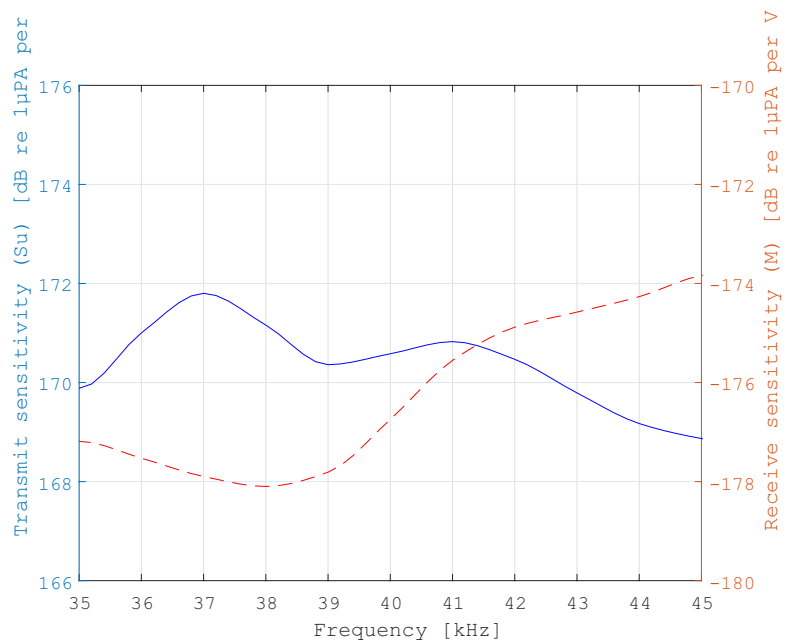
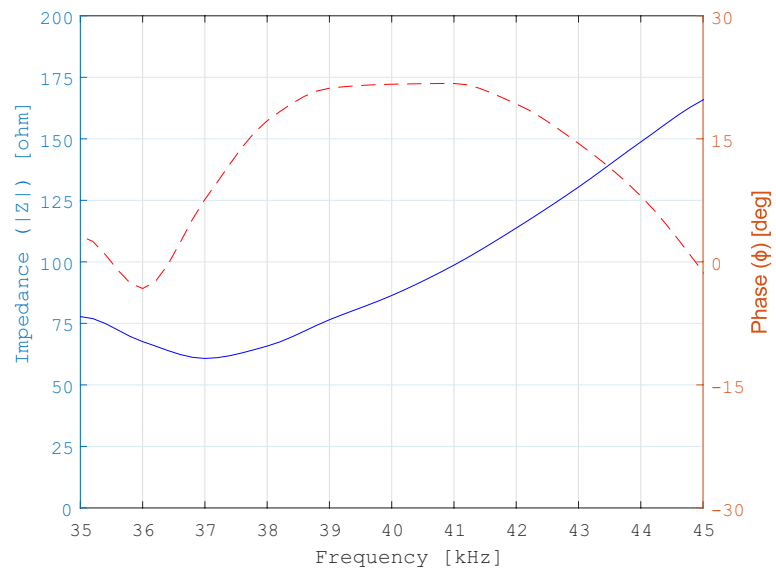
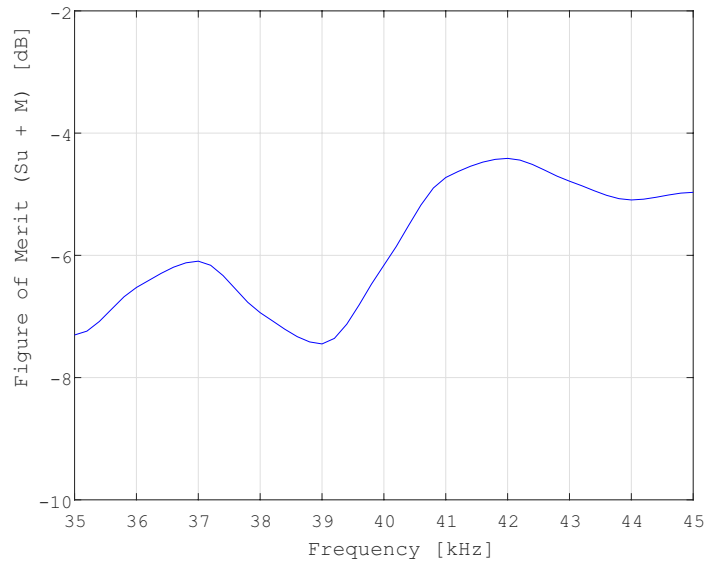

## Technical specifications

The technical specifications and requirements provided are those valid when operating at the nominal frequency with all sectors excited simultaneously.

Kongsberg Maritime are continuously working to improve the quality and performance of our products. The technical specifications may be changed without prior notice and the specifications refers to typical figures for the product.

## Performance specifications

- Nominal frequency: 38 kHz
- Frequency range: 35 to 45 kHz
- Beamwidth: 18°
- Depth rating: 1500 m
- Figure of merit: -10 dB
- Max. source level: 212 dB re  $\mu\text{Pa}$  per V @ 1 m
- Transmit sensitivity (Su): 174 dB re  $\mu\text{Pa}$  per V @ 1 m
- Receive sensitivity (Mt): -184 dB re 1 V per  $\mu\text{Pa}$  @ 1 m
- Sidelobe level: -17 dB
- Back radiation level: -20 dB
- Impedance (each sector): 75  $\Omega$

## Power specifications

- Max. transmit power: 450 W
- Max. pulse length: 8 ms
- Max. duty cycle: 2 %

## Weight and outline dimensions

- Physical dimensions:
  - Diameter: 190 mm
  - Height: 212 mm (body)
  - Total height: 78 mm
- Weight
  - In air: 9.2 kg (incl. cable)
  - In water: 5.5 kg (incl. cable)
- Cable length and termination: 2 m with 8-pin male SubConn® connector (MCIL8M)
- Cable diameter: 10.4±0.5 mm
- Bending radius:
  - Static: 100 mm (theoretical)
  - Dynamic: 150 mm (theoretical)

## Environment requirements

- Storage temperature:
  - Max.: +60°C
  - Min.: -20°C
- Operating temperature:
  - Max.: +40°C
  - Min.: -5°C

## ES38-18DK Split-beam transducer, typical figures

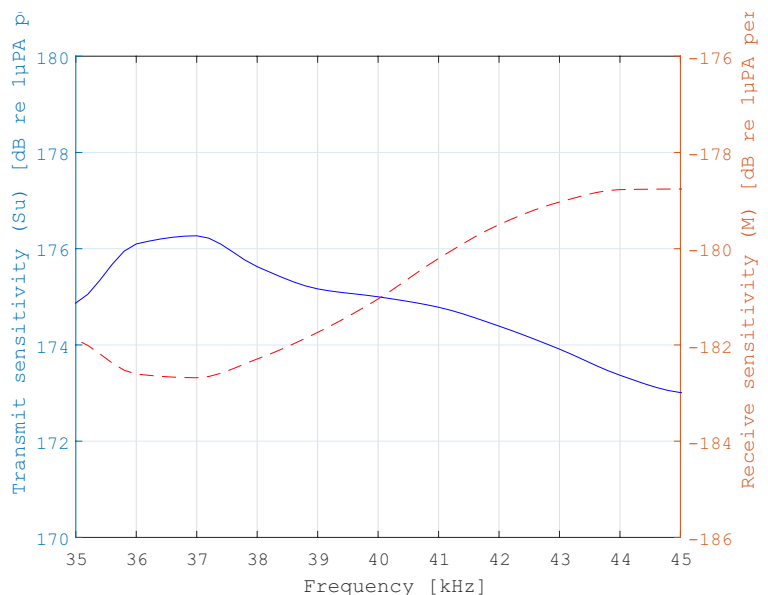
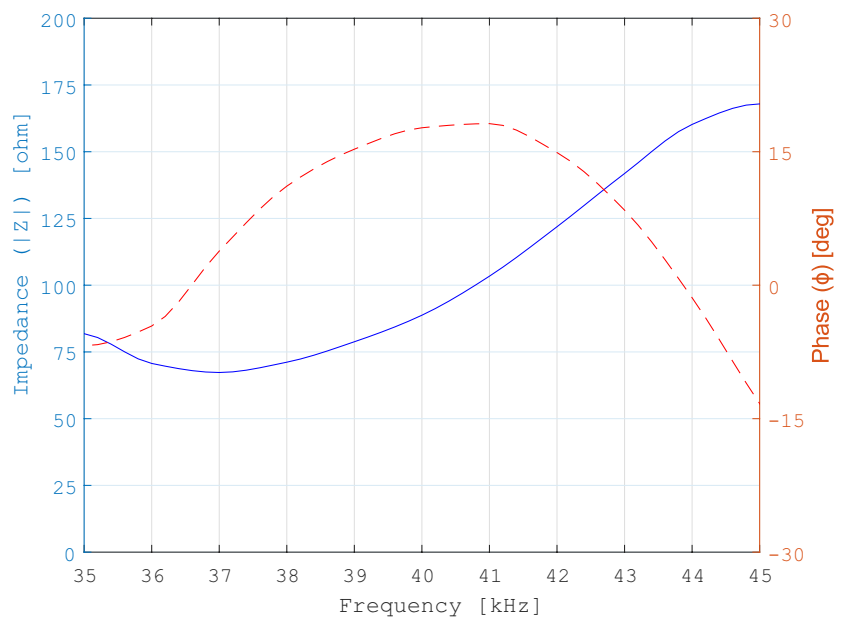
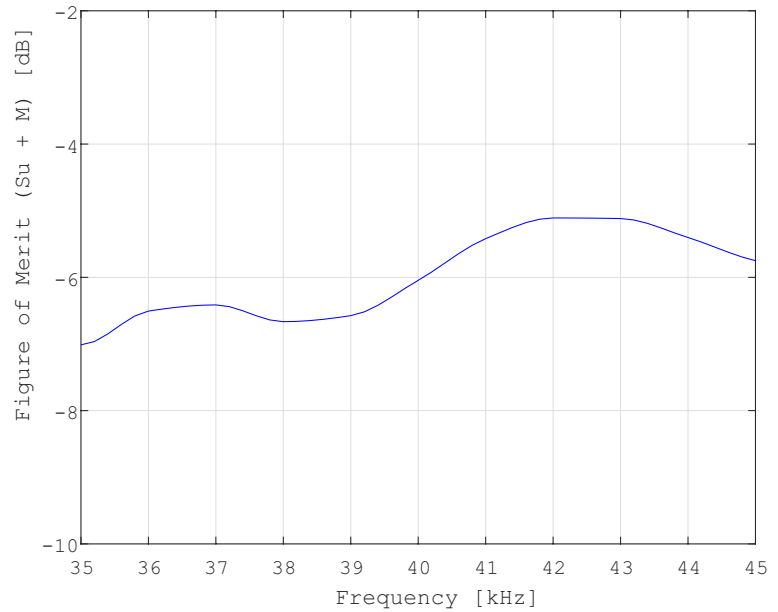

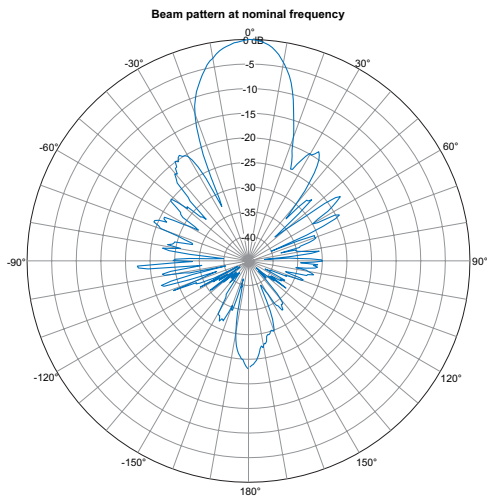

Beam pattern

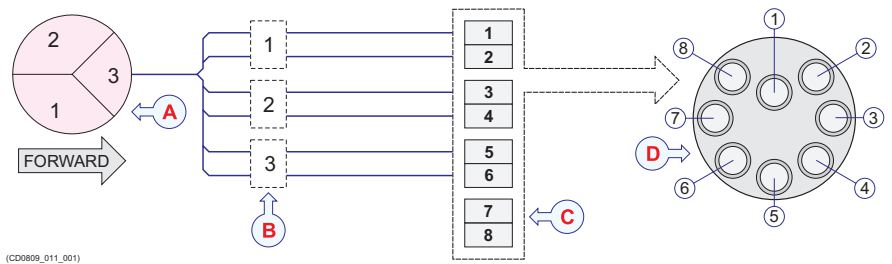
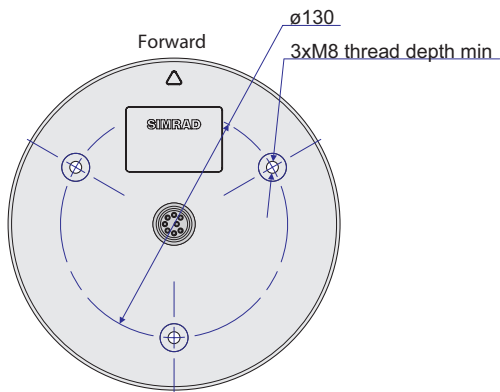
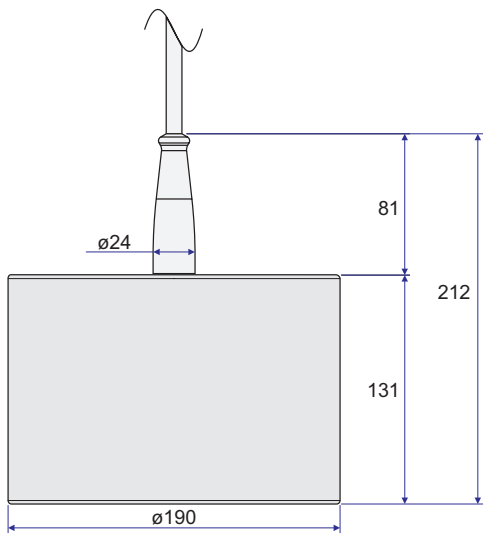

(CD0809\_011\_001)

### Connections for split-beam configuration

The transducer is delivered with a MacArtney MCIL8M connector. Pinout looking into the plug is shown at the right in the figure. This connector is used for the WBAT, WBT Mini and WBT Tube (WideBand Transceiver).

- (A) Transducer seen from above - observe the sector locations relative to the forward direction!
- (B) Sectors
- (C) Terminals
- (D) Transducer plug face view

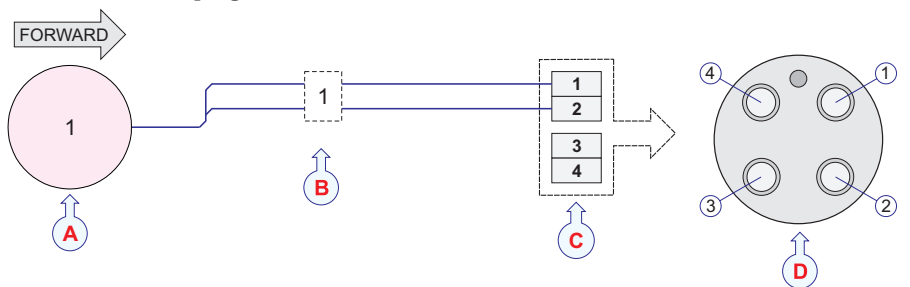

### Connections for single-beam configuration

The transducer is delivered with a MacArtney MCIL4M connector. Pinout looking into the plug is shown at the right in the figure. This connector is used for the WBAT, WBT Mini and WBT Tube (WideBand Transceiver).

- (A) Transducer seen from above - observe the sector locations relative to the forward direction!
- (B) Sectors
- (C) Terminals
- (D) Transducer plug face view

### Rules for transducer handling

To secure the long life and accurate results, the transducer must be handled correctly.

A transducer must always be handled as a delicate item. Wrongful actions may damage the transducer beyond repair. Observe these transducer handling rules:

- Do not activate the transducer when it is out of the water.
- Do not handle the transducer roughly, avoid impacts.
- Do not expose the transducer to direct sunlight or excessive heat.
- Do not use high-pressure water, sandblasting, metal tools, or strong solvents to clean the transducer face.
- Do not damage the outer protective skin on the transducer face.
- Do not lift the transducer by the cable.
- Do not step on the transducer cable.
- Do not damage the transducer cable, avoid sharp objects.

